



By Appointment to Her Majesty the Queen • Motor Mower Manufacturers Charles H. Pugh Ltd

The

ATCO

Motor Mower

MANUAL

THE
ATCO
MOTOR MOWER
MANUAL



CHARLES H. PUGH LIMITED

P.O. Box No. 256

ATCO WORKS . TILTON ROAD . BIRMINGHAM 9

England

Telephone : VICTORIA 2524 (4 lines)

Telegrams : Accuracy, Birmingham

CONTENTS

	Page
Hints about Motor Mowing	3
Lawn Construction and Maintenance . . .	13
Maintenance and Operating Instructions .	17
The ATCO Service Organisation	33
The ATCO Service Branch Addresses . . .	41

HINTS ABOUT MOTOR MOWING



Brought together in this form from conversations and correspondence with practical users of every description from 1921 onwards and blended with our own mowing experience and that of Atco Service Branches who are able to observe the behaviour of Atco Products on the lawns, playing fields and other areas throughout Great Britain.

The Hints are based on a paper written some years ago by a former Director who had been an enthusiastic motor mowing practitioner before the first Atco was made.

If, in printing a revised version, they appear old-fashioned here and there, it is probably due to our desire not to lose the atmosphere of enthusiasm and good sense which characterised his notes.

Charles H. Pugh Limited.

ABOUT MOTOR MOWING

I have motor-mowed lawns one way or another and with various machines for what seems ages: every growing season, including a little, as far as the ration permitted, each year of World War II.

That shows I am getting a lot older now and with it more inclined to be lazy and save myself toil and irritation. One difficulty about long experience is that some of the hints and things must have appealed to me differently when I was 21, 30, 40, and so on. However, that is inevitable in life and one can only hope that the principle of an ordered approach to the task may be helped by these notes. In any event, I admit that I often fail to do the things at all, let alone often enough: including witlessly forgetting on one occasion to mow before the Garden Fete!

I have also had to endure the calamitous hair raisers and disturbers of that much desired green sward tranquillity, such as cows getting in, digging dogs, subterranean invasion by moles and so forth, just as we most of us experience. I have likewise failed my loving family and household on occasions in this matter: and more than once emptied grassful trouser turnups indoors, which is why if you ever saw me using my best garden ally, it would nearly always be with trousers tucked into socks! Well here goes — where do I start? Not with buying the machine of the right size, shape, style. That I assume has been done and, I hope, correctly, after weighing-up the lawns, the mowing job and the pros and cons generally. If not, somebody is going to be in the long grass in several senses.

No, I will start on the lawn itself by saying that, belonging to what is by far the greatest number of the motor mowing community, I am happy if my lawn area looks nice and green and



... instruction for his household,
some of them from an early age.

... prevent costly damage by using a mower carrier when traversing yards and paths.

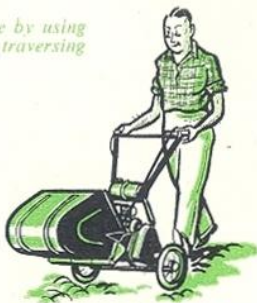

sheer after mowing and for several days thereafter. Down the years I have had several campaigns aimed at making and keeping them up to a perfectionist's standard, but I have always (such is human frailty) relapsed; and so we are dealing with an average greensward by no means inhabited exclusively by the finer or even passable grasses.

In any event the minority who are either rich enough or enthusiastic enough or are compelled to maintain bowling green/golf green standards (or similar) will certainly have to be more punctilious about my Hints than I could ever be. They will also have to have more time, more skill and more help than comes the way of most of us.

Well then we have a greensward of a kind and a motor mower to tend it with, quite the principal labour saving tool we shall employ in the garden.

Here follow some "articles of faith" which would have saved me, if meticulously followed down the years, most of the pitfalls which confront us all from time to time on the lawns.

GENERAL

1. Uncharitable, but sound: don't lend it to anyone!
2. Get things right about the fuel, etc., from the start and secure continuity.
3. At the right age get your family keen on learning the proper management of the job. This for educational as well as home maintenance reasons.
4. House it under cover, reasonably dry, away from corrosion-causing chemicals; and as near the greensward as possible. Prevent costly damage by using a mower carrier

when traversing yards and paths. Try to prevent it being used as a shelf for old sacks and what not, or as a prop for spades and other implements. Also ensure if you can that its rightful space is respected and that you can always get it in and out without clearing a way for it.

5. Brush and wipe the bits off it in two or three minutes “after” use (not “before”) and, supposing the actual mowing to be an hour or so a week (pro rata for the wrong sized equipment) use the oilcan or grease gun every two or three times of using. Don’t forget the front roller, which is so often left until it literally screams for oil in an alarmingly realistic imitation of some much worse trouble!
6. Prevent self-styled engineers with time on their hands from tampering with it, whatever their qualifications.
7. House any Lawn Edge Trimmer you use handy to the motor mower and treat it equally well.
8. Don’t ever “savage” the machine as I confess that occasionally the years have seen me do — always disadvantageously and often painfully. There are many ways of “savaging” but I need only cite three:
 - (1) If you have a kickstart, engage the lever or striker first before “kicking.” Anything more “savage” than to bash the thing into engagement all in one terrific kick is hard to imagine.



- (2) If you have a *recoil* starter don’t pull until you (likewise) have taken-up the play and don’t “try” to pull it away from its anchorage at the finish of the pull.

Prevent self-styled engineers with time on their hands from tampering with it.

*... don't try to pull the recoil
starter away from its anchorage!*



- (3) Don't go on at either when there is obviously "nil" result: seek the cause of not starting. Using the process of elimination suggested in the instructions.
9. You ought to fill tanks through a funnel and filter and keep it with the machine. Not only to filter fuel but to minimise spilling, even if you have a spout on your reservoir can. Some people use an old nylon stocking as a sieve in the funnel. If you (or the borrowing gang) decide you must do without, then refuel on a path or at least where some inevitable spill will not matter. Incidentally, if you are fairly conscientious about all these contributory matters, you need hardly fear carburettor flooding.
10. But if you get it, turn off petrol and stuff a rag under the overflow until you can move on to a non-lawn place to deal with the situation.
11. It generally pays to move the machine off the grass for adjustments. Although in this I have been at fault very often, you can spill fuel or oil by tipping the machine back on its handles for attention. Always turn off the petrol before tipping the machine in this way.
12. When you have got down to a "routine," subject to minor variants to suit varying conditions, a general rule of priceless value is "Let Well Alone."

ME AND MY MOWING

I don't think the fact that everyone is so much more mechanically-minded in this second half of the twentieth century or the

attitude that one knows the lot from experience at push mowing, are sufficient reasons for omitting the following items.

1. Vary the mowing plan, the depth of turning - headlands, and the directions of mowing because this will be good for the lawns and for you, but do this as a variation on what you have established by experience as the standard cut for the shapes and slopes concerned.

There is often scope for some re-shaping of the lawns and mown area which alters and improves the garden appearance as well as facilitating our work. This extends to the siting of new shrubs and bulb naturalising operations but perhaps not to moving well-established favourites.

2. No edge trimmer of my experience does well if the edges are not firm, sheer and sufficiently deep. Twice a year the special D-shaped tool should be used to help recover the required condition and thus ensure that the edges embellish the greensward.



3. Don't shave the lawns very closely. It exhausts the sward, makes the job unnecessarily exacting on driver and machines, and is undesirable except for highly specialised requirements. It is better to mow rather more frequently and less keenly.





4. Carefully search for and remove all stones, sticks and other hard objects from the lawn area to be mown.
5. Do not hurry or race. Better do the job in two bites at the speed which gives the right feel. Speeding sets up all sorts of stresses in man and machine, spoils any gentle-smoothing effect, causes imperceptible bumping and “lift,” or worse, and makes it difficult for the blades to gather their proper “mouthful.” There exists—even in the best regulated establishments — the risk of loose or anchored hard objects which reach the blades despite the driver’s undeviating vigilance! At slow and permissible speeds the danger of damage to properly made blades is slight, although the “cut” may require re-adjusting after a particularly unyielding thump or crack. At a jog trot the risk of damage is vastly increased. Flat out, sooner or later, even the best machine is liable to shed some hard substances of its own to add to the menace and impair its efficiency. Which reminds me, a spanner around the nuts occasionally is a very worthwhile precaution.
6. Grass disposal gives great scope for personal taste and I will only venture some remarks compiled from my own preferences and those of some of my brother users in our numerous category. I have rotted it down for compost, spread it thinly around shrubberies, given some to hens, etc. All these solutions have a place in the general scheme; none are completely proof against, for instance, the menace of straying hens or blackbirds, whose backheeling method of foraging sprays grass and leaves over considerable distances.

Certainly the grass should not be “flown” unboxed by our category of user, when it is long enough or can become

moist enough to stick to the rollers, one's shoes or a rolling ball.

A hessian square laid out to plan is one good receptacle on which to empty the grass box provided it is "shouldered" and taken to the emptying place before being overfilled. The wheelbarrow with or without extensions is a time honoured maid of all work, and a routine worked out around it as the central piece in the transfer of grassbox contents to final destination is probably the most generally adopted plan.

There is a caveat here, that many may not agree with but I feel I would like to put it in. It is much more strain for me (and was even when young and very vigorous) to tip the wheelbarrow load on to the main heap than to scoop the contents out with two suitably shaped boards or, failing this, both hands with fingers open.

7. One of the advantages of the power propelled machine is that you can mow in much wetter and more awkward conditions thus avoiding postponement and nervous irritation arising therefrom. This is equally true of mowing grass that has been recently sown as, provided the cutter is cutting cleanly along its whole length, there is very little tendency to drag the new grass up by its roots.
8. The amount of overlap of swathes comes with practice and is part of the general routine when established; so is the mowing of banks and undulations, the latter feature being incorporated in the writer's lawns wherever feasible, to give the effect of miniature downlands.



LASTLY

When the task is reduced to a routine which may be followed (with deviations) throughout the 30 or 40 mowings of the average

Speeding can cause bumping and lift, or worse . . .

English season, it has always been for this writer healthful exercise well within his capacity for these many years and likewise for his household, some of them from an early age.

It is rewarding work, for, if done nicely, the greensward, however heterogeneous in its botanical make-up, is a satisfying sight, and is and has been the basic feature of the garden from the day when "expert scythesmen cut it and huge stone or iron cylinders rolled it," as a 17th century continental visitor wrote.

It is an act of husbandry that should be good for the mind no less than the figure. If, at times, it mortifies the flesh and the soul, it will, in my impartial experience, be due much more, often than not to some oversight in our preparedness or some chance interruption.

To those few who have got as far as this, the opportunity now arises to say two things.

First, wish them as much pleasure as I derive from mowing. Second, to plead that I have tried hard not to dogmatise in a matter where dogmatism would not be tolerated anyhow.

CONCLUSION

We owe so much to the specialists and scientists, whether at Research Establishments or associated with firms of seedsmen and suppliers of garden requirements, as well as to private pioneers and travellers and the gardening journalists, that it would be ungrateful to conclude without referring to the advice and help which they can give in matters of the greensward and the garden.

We salute them for all they have done and continue to do over a vast field which we leave to them with a sense of confidence and considerable relief.

Theirs is a great part in securing for us and for posterity the beauty and the joy of the garden scene.

CHARLES H. PUGH LIMITED.

AND MAINTENANCE

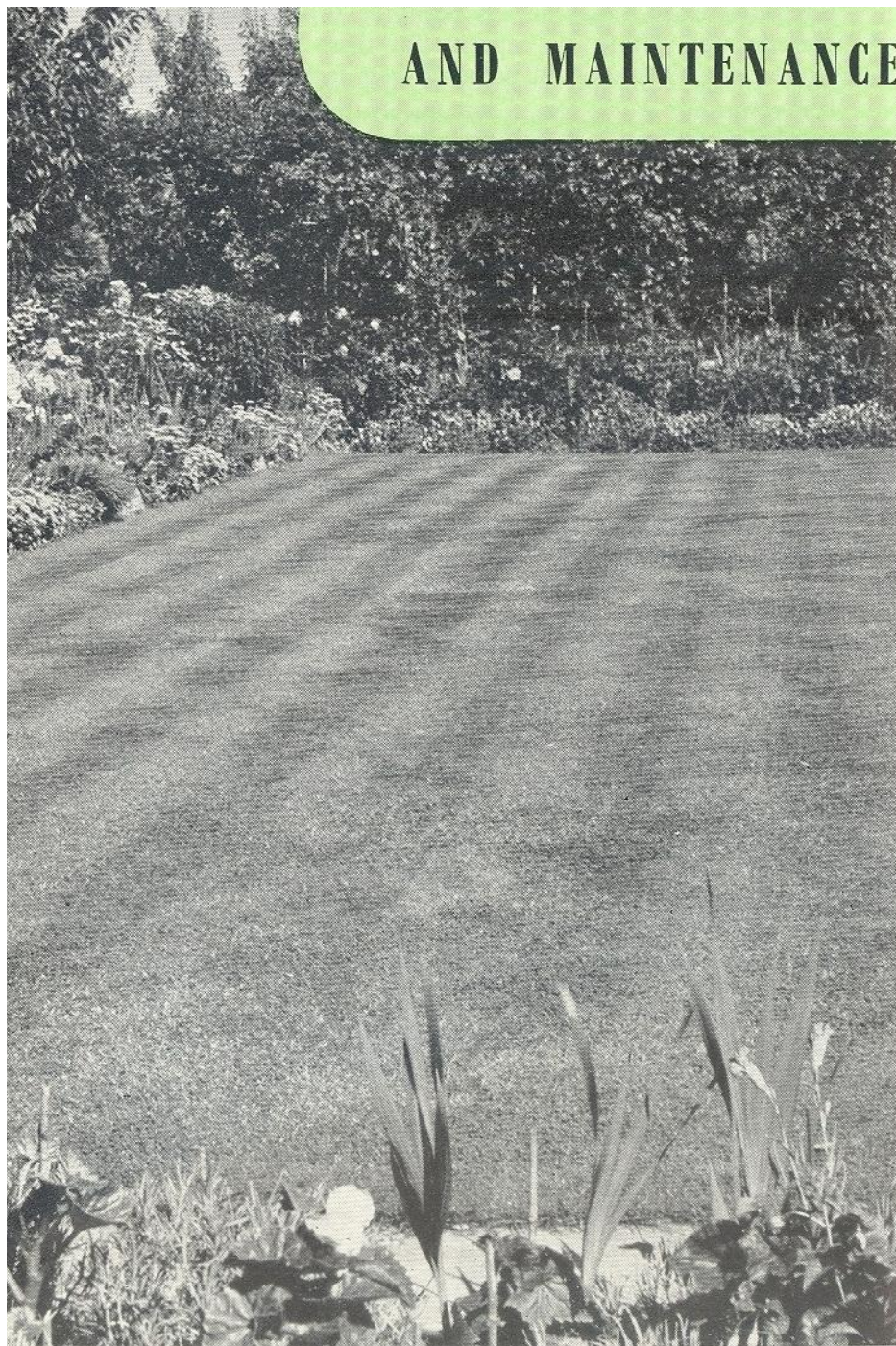

*... reproduced by courtesy
of the Sports Turf Research
Institute, which retains the
copyright*



A well kept lawn is a feature of our gardens and helps to bring out the character and beauty of its surroundings. It is also a thing of beauty in itself if constructed and maintained in a proper manner.

It is a mistake to assume that “grass just grows” and that a good lawn can be made and maintained without any work. On the other hand the number of subjects covered in the following notes might suggest that an impossible task is being given! The reader will find, however, that intelligent application of suitable sections will produce results with much less trouble than might at first be anticipated.

CONSTRUCTION OF NEW LAWNS

1. Levelling

Minor adjustments in existing levels can be accomplished by moving top soil or by importing additional top soil. However, it is important that not less than 4” of good top soil should remain on the surface so that major adjustments must be made in the sub-soil. This calls for the careful removal and preservation of the top soil, grading in the sub-soil and then returning the top soil evenly. At no time should top soil and sub-soil be mixed.

2. Drainage

It is difficult to give a general guide here. On many lawns drainage will not be required; on some, a simple rubble

drain terminating in a rubble filled sump or soak-away will be sufficient, whilst others may need a tile drain system possibly connected to the Local Authority's storm water drains (if permission can be obtained).

3. **Preparation**

The top soil should be well dug over and thoroughly cultivated. Ideally it should be left in a dug condition over winter and cultivated all the following summer at intervals as a fallowing operation to get rid of weeds. Ultimately we require a firm, fine seed bed as clean as possible of rubbish and, of course, during the work required all sizeable stones and roots of grasses and weeds should be got rid of.

4. **Soil Improvement**

On very heavy soils it is an advantage to cultivate into the soil coarse gritty material like sharp sand and organic matter such as well rotted farmyard manure or fine peat, leaf mould, etc. On light soils also organic matter is advantageous.

Chemical improvement of the soil may also be required. If it is acid, lime will be needed but this should be avoided unless proved necessary.

Fertilizer treatment will also be required, and a week or ten days before seeding a good general fertilizer should be applied, unless the ground is known to be rich. (See MAINTENANCE No. 3 — Fertilizer Treatment (Feeding)). When turfing it is often sufficient to apply 1 - 2 ozs. of bone meal per square yard plus some potash fertilizer if the soil is light and sandy or known to be deficient in potash.

5. Seeding or Turfing

It can be taken that seeding is cheaper and more satisfactory in the long run if the preparatory work is efficient. Turfing, however, is quicker and will cover a multitude of sins. It is, however, difficult to get hold of good turf. General preparation for turfing is the same as for seeding.

6. Seeding

Whilst a spring sowing is reasonable, particularly if it is possible to water, best results are usually obtained from a sowing at the end of the summer, say the last week in August. Seed sown at this time is sown in warm soil and once there is sufficient water for it to germinate and establish, there is usually little risk of drought and the grass gets well away before any severe winter weather. A sowing at this time is also less likely to be adversely affected by weeds. With a spring sowing one is liable to run into a dry May just when the grass is most susceptible and, of course, weeds generally get away vigorously.

A suitable seeds mixture for a really fine lawn for ornamental purposes or for first class tennis, etc., consists of:

8 parts Chewings' fescue
2 parts Browntop

to be sown at the rate of 1 oz. per square yard. For second quality lawns, other grasses such as Crested dog-tail can be added. One can also buy a proprietary mixture when, roughly speaking, the more one pays the better the mixture.

The seed should be spread as carefully as possible by hand dividing it into small portions to cover measured areas evenly.

7. Immediate after care of sown turf

When the seedlings are about 2" high any surface stones should be picked up and the lawn carefully rolled. When the grass regains the vertical it should be topped with a sharp mower. If further cutting is required before the following spring (assuming an August sowing), care should be taken not to cut very short. A further light rolling will be required when the surface is dry in the spring and in order to get a smooth surface, top dressing with screened top soil or compost is advantageous. (See MAINTENANCE, No. 7). In the first complete year it is important to keep the grass growing by applying light dressings of nitrogenous fertilizer if there are any signs of the growth falling off. Suitable treatment would be two or three dressings in the year of sulphate of ammonia ($\frac{1}{2}$ oz. per square yard) mixed with screened top soil (8 oz. per square yard).

8. Turfing

The preparation of the soil bed is fairly similar to that for seeding. The difficulty starts when one tries to get good turf. The chosen turf should be of suitable fine grasses and weed free but it should not be too fibrous. The sods should be of uniform thickness (say $1\frac{1}{2}$ in.) and should be laid with joints closely butted and alternating in a manner similar to bricks in a wall.

When laying has been completed, careful rolling with a light roller is required. The next operation is to spread over the surface, by means of a shovel, a liberal top dressing (say 5 lbs. per square yard) of a mixture of sharp sand (lime free) and screened soil brushing it well into the joints and generally trying to produce a smooth surface.

continued on page 42

ATCO

12 inch and 14 inch
Four-Stroke Motor Mowers

MAINTENANCE AND OPERATING INSTRUCTIONS

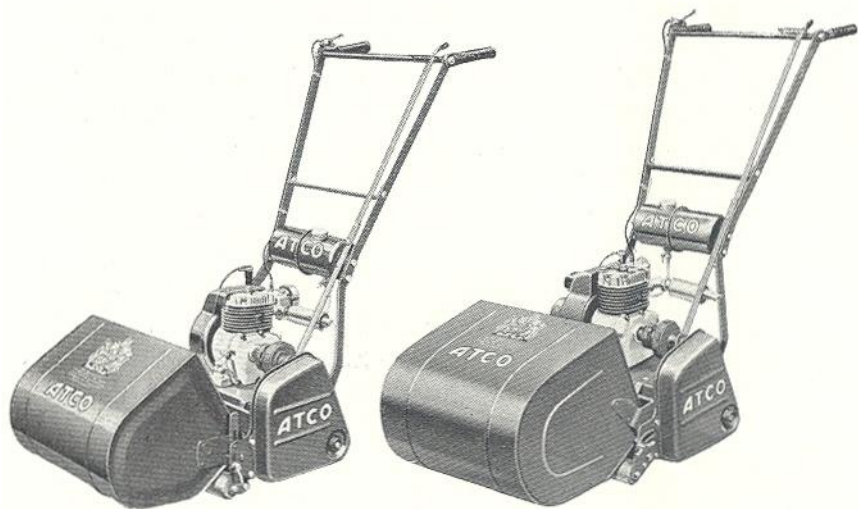

FUEL

Fill the petrol tank with medium grade petrol using a fine gauze funnel to ensure that petrol quite free of foreign matter, enters the tank. Tank capacity $2\frac{3}{4}$ pints.

Remove oil sump filler cap located at the front of the engine crankcase at (A, Fig. 1). Using a high quality oil, having a viscosity of S.A.E.30, fill oil sump until oil level is only just visible at elbow of filler tube. *Check* that oil is at this level before each mowing session and replenish when necessary. When filling the sump ensure that the machine is standing on level ground *and that the front rollers have been set to provide the lowest cut; do not undertake this operation while the engine is running.*

NOTE. Always clean vicinity of oil filler cap quite free of dirt and grass cuttings, before removing it, to ensure that nothing but pure oil enters the sump.

Reset front rollers to the required height of cut.

NOTE The correct way to fit the rubber cap in sump filler hole is to place a small amount of oil on the cap end and hold it *squarely* over the hole. Press *gently* and twist until cap is securely in position.

Drain oil from sump after the first 5 hours' operation

The easiest way to do this is to tilt the machine forwards on its front rollers and allow the oil to drain through the oil filler hole at the front of the crankcase. Ensure that

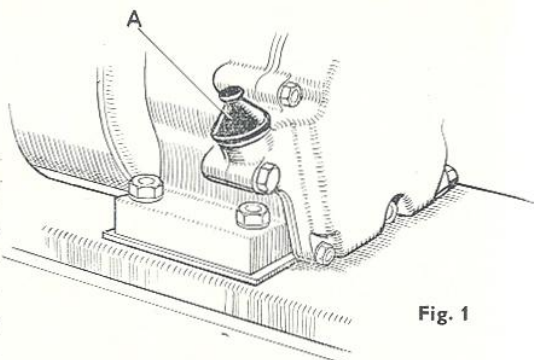

Fig. 1

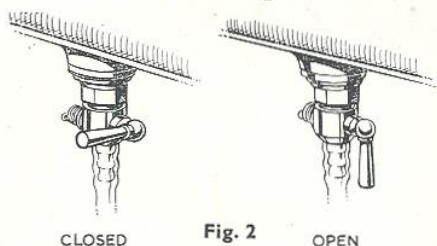

Fig. 2

CLOSED

OPEN

all the old oil has drained away by leaning the machine slightly over top dead centre of the front rollers. This is best done while the engine is warm, as the oil will then run out freely. Refill with clean new oil of the correct grade. Sump capacity, $\frac{1}{2}$ pint. Thereafter the oil sump should be similarly drained and replenished at least twice during the mowing season. In dusty conditions and where long hourage mowing is undertaken, this operation should be carried out more frequently. *Failure to do so regularly will promote early engine wear. For the same reason, before starting engine please refer to the instructions under "Air Filter" on page 30.*

NOTE. In very hot climates with an air temperature above 90°F. use an oil with a viscosity of S.A.E.40.

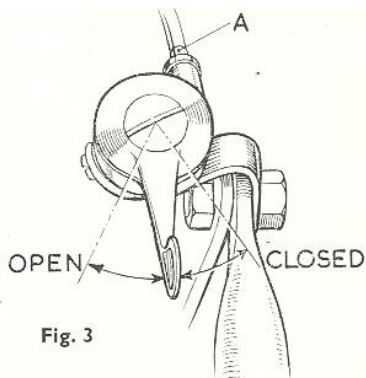

Fig. 3

STARTING FROM COLD

1. Ensure that the petrol tank and engine oil sump have been filled with the correct grade of their respective fuels as referred to on page 18 and that the air filter (B, Fig. 14) is oil wetted. (see page 30)
2. Open petrol tap (Fig. 2).
3. Open throttle lever (Fig. 3) approximately to the halfway position. Close choke by depressing the choke lever (B, Fig. 15). Only in cold conditions may it be necessary to depress the carburetter tickler (A, Fig. 4).
4. See that the clutch lever (Fig. 5) is in the "OUT" position.

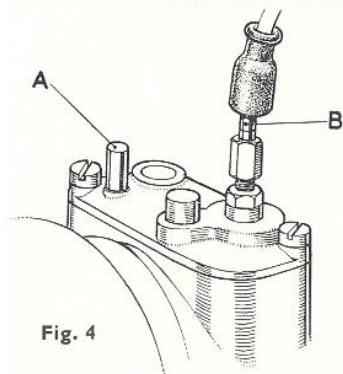

Fig. 4

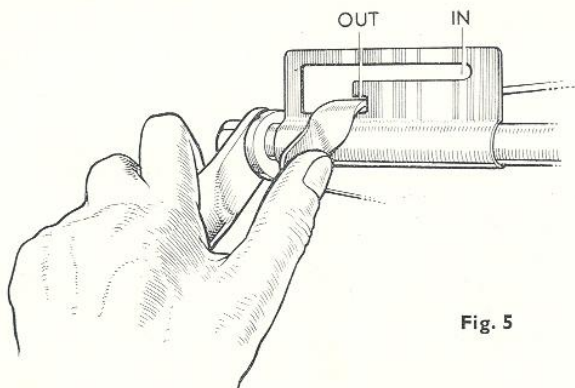

Fig. 5

5. Start engine by using the recoil starter.

NOTE. Starting by recoil starter is an easy and simple operation if undertaken correctly. Take hold of recoil starter grip (A, Fig. 6), and slowly withdraw nylon cord until just over compression of the engine, then allow the starter cord to rewind fully. Withdraw cord slightly until the starter ratchet is felt to be in engagement. Now with a short smooth pull, the engine should start. *It is quite unnecessary and undesirable to "snatch" or to withdraw the cord to full extension in order to start the engine.*

Finally allow the starter cord to recoil, *under control*, until the grip reaches its normal position of rest.

6. While engine is warming up, gradually lift choke lever until fully open. Leave in this position for working and for starting while the engine is warm.

Alternative method of starting

If failure of the recoil starter should occur, an emergency method of starting is provided. Proceed as follows : Remove three starter mounting nuts (B, Fig. 6) and the starter body (C, Fig. 6) complete. With the knotted end inserted in the pulley notch, a length of cord may then be wrapped round the emergency starter pulley (D, Fig. 6). Start the engine in the usual manner.

TO SET THE MOWER IN MOTION

Move the clutch lever gently from the "OUT" to the "IN." position, at the same time opening the throttle slightly. To stop machine, reverse the procedure.

The clutch control and the single lever throttle give complete control over the machine.

STARTING FROM HOT

Proceed as for starting from cold but do not close choke.

IF THE ENGINE WILL NOT START

Should the engine fail to start it will probably be due to one of the following reasons :

1. Petrol tank empty or fuel filter (E, Fig. 15) at base of carburetter blocked. Remedies : Fill tank. With petrol turned off, remove and clean fuel filter. (To locate fuel gauze filter. See page 29.)
2. Dirt or water in the fuel will cause bad starting or erratic running. Remedy : Clean out tank, fuel supply and carburetter. (See carburetter, page 27.)

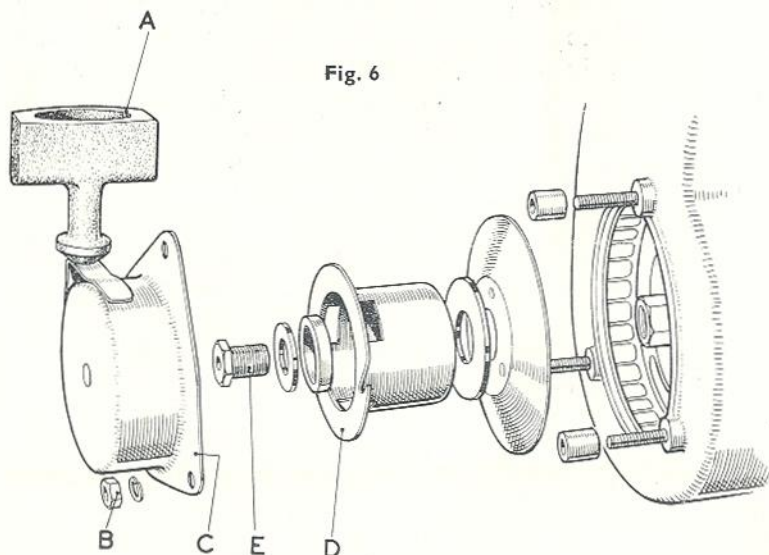

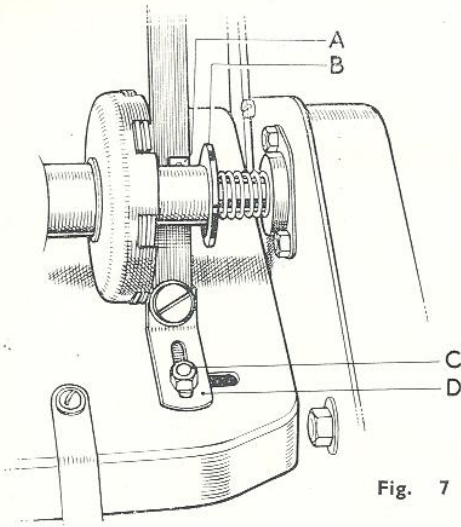

Fig. 7

3. Mixture too rich due to use of tickler (A, Fig. 4), or to use of choke when warm. Remedy: Turn off petrol, open throttle wide and turn engine over slowly a few times with the recoil starter. Reset throttle lever turn on petrol and start engine.
4. Air filter (B, Fig. 14), blocked by dirt. (See air filter, page 30.)
5. Defective sparking plug. Remedy: With H.T. lead attached, hold plug on top of engine and check that spark is visible at the points when engine is rotated. If not, clean the plug as follows: Wash the plug well in pure petrol. Dry thoroughly and replace the plug. The engine should now start. If however, the interior of the plug is heavily coated with solid carbon deposits, it should be cleaned or replaced. Cleaning of the interior of the plug is preferably done by sand blasting at a garage. Adjust plug gap to .020 inches. If no spark is visible after the above has been carried out, replace plug with one of the same type as fitted by the manufacturers. Lodge C.N.

NOTE

The cylinder head has been cast from an alloy to provide lightness and additional cooling for the engine. It is therefore most important that the plug is not over-tightened, otherwise stripping of the threads in the sparking plug hole may result.

ROLLER DRIVE RELEASE

(for mowing in confined spaces)

To disconnect drive to rear roller, withdraw sleeve (A, Fig. 8) until the notch (B, Fig. 8) clears the slot in the outer washer and turn either right or left to secure, (C, Fig. 8).

To engage, reverse this procedure.

MOST IMPORTANT. Do not attempt this operation unless the mower clutch lever (Fig. 5) is in the "OUT" position.

LUBRICATION

The same oil as used in the engine sump is suitable for lubricating your ATCO Motor Mower, and the periods for lubrication recommended are an approximate guide for machines which are in use for a few hours a week, but where machines are in greater use, lubrication should be carried out more frequently.

Place a spot of oil between the pad on the clutch operating lever and clutch withdrawal collar (A, Fig. 9) frequently, to ensure machine drawing backwards freely.

A few drops of oil fortnightly

- (a) All chains.
- (b) Between the front rollers (P, Fig. 9) and on the shaft at each end. From time to time the front rollers and

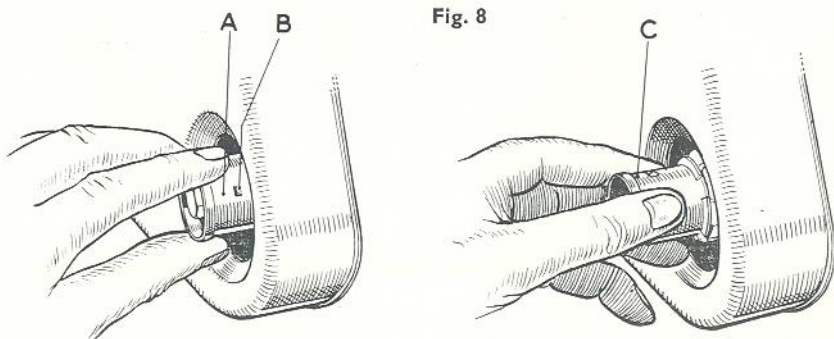

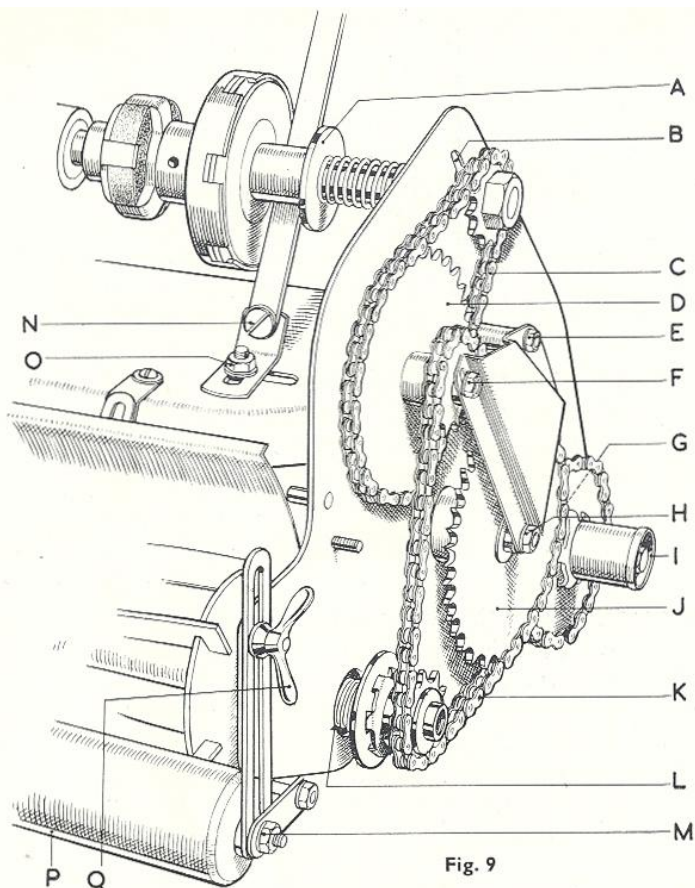

Fig. 9

shaft should be removed, thoroughly cleaned and lubricated. To do this (12" model) remove the nut (M, Fig. 9) on front roller shaft and wingnut on the front roller bracket on either side of machine. Remember to replace washers between rollers during re-assembly. (14" model) It is only necessary to remove nut (B, Fig. 11) on either side of machine to release front roller shaft through slots provided.

(c) Drive Side. Clutch shaft and rear roller shaft bear-

ings (B and G, Fig. 9), through slots in side frame located between chain wheels and side frame.

Cutter shaft bearing (L, Fig. 9), through cutters adjusting slot.

- (d) On the spindles on either side of the intermediate chain wheels (D and J, Fig. 9).
- (e) Sliding member of roller drive release (I, Fig. 9).
- (f) Clutch pivot pin (N, Fig. 9).
- (g) Cutter shaft bearing and rear roller shaft bearing on the other side of machine. Access is provided by sliding two oil hole covers (A, Fig. 10) aside.

A few drops of oil monthly

Both ends of the throttle inner cable (A, Fig. 3) and (B, Fig. 4). Expose these by drawing back the outer cable a little way by hand.

ADJUSTMENTS

Cutters

Cutting cylinder to bottom blade. As wear takes place the cutting cylinder has to be lowered on to the bottom blade. By rotating adjustors, (A, Fig. 12) one on either side of machine, the cutting cylinder is brought closer to the bottom blade and vice versa. This adjustment should be carried out a little at a time at each end of the cutting cylinder until each blade will cut

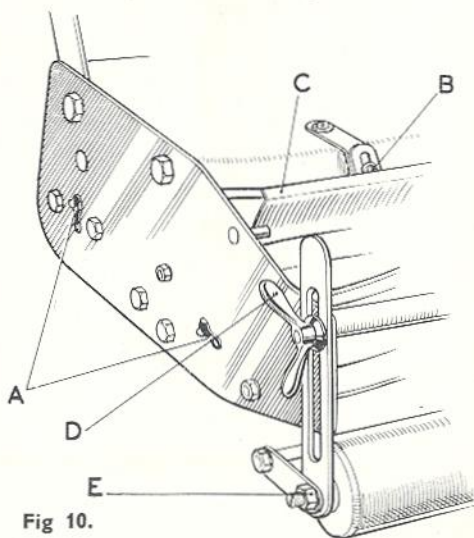

Fig 10.

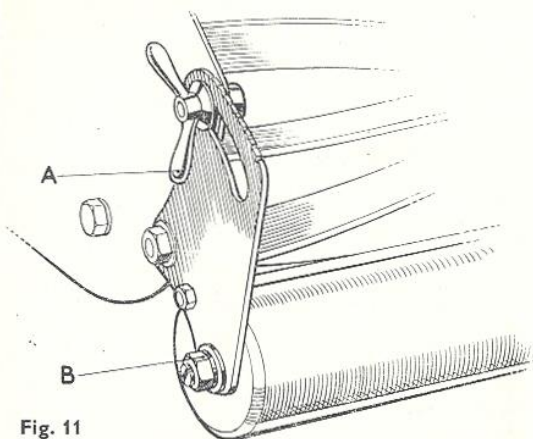

Fig. 11

paper evenly along the whole length of the bottom blade. Do not adjust bottom blade too hard against cutters or undue wear will be caused.

NOTE. Reduction in the diameter of the

cutting cylinder, either through wear or regrinds, can be compensated by transferring one of three washers(C, Fig. 12) from below the adjuster spring to a position above the fixed bracket (B, Fig. 12). This adjustment should be carried out evenly at each end of cutting cylinder.

Grass delivery plate

(for regulating the "throw" of cut grass).

As wear takes place on the cutting cylinder it may be necessary to adjust the grass delivery plate closer (C, Fig. 10) to the cutter. This adjustment is effected by loosening two screws (B, Fig. 10), and depressing plate to suit the particular need. Tighten nuts.

Clutch

Adjust the clutch while the clutch operating lever (Fig. 5), is in the "IN" position. Undo the nut (C, Fig. 7) securing the pivot pin bracket and move the bracket along the slot in engine platform until there is approximately $\frac{1}{2}$ " of free movement of the clutch lever in the gate (Fig. 5). Tighten bracket nut firmly.

Chains

Clutch to upper intermediate chainwheel (C, Fig. 9) and cutters to lower and upper intermediate chainwheels

(K, Fig. 9). Loosen three nuts (E, F and H, Fig. 9) securing transmission spindles support plate. By slackening the upper intermediate chainwheel (D, Fig. 9) spindle nut, located on the inside face of the side frame, both chains can now be adjusted by moving the upper intermediate chainwheel assembly in the desired direction. Allow a little free movement of chains. Tighten the inside spindle nut and finally the other three nuts. *Check that there are no "tight spots" on chains by rotating cutters backwards. Re-adjust, if necessary.*

Front rollers

For height of cut. Slacken off wing nuts (Q, Fig. 9), and (A, Fig. 11) one on each side of machine, and raise rollers for a shorter cut and lower for a longer cut. Tighten nuts firmly.

Handles

Adjust the handle grips one at a time to avoid the position of the clutch lever gate being altered. Slack off the single nut on each handle grip and re-tighten very firmly after adjustment.

CARBURETTER

The carburetter setting is normal when the groove plate (A, Fig. 13) is in notch No. 2 of the taper needle (B, Fig. 13). The mixture will be enriched by using notch No. 3 or weakened by using notch No. 1. A finer setting

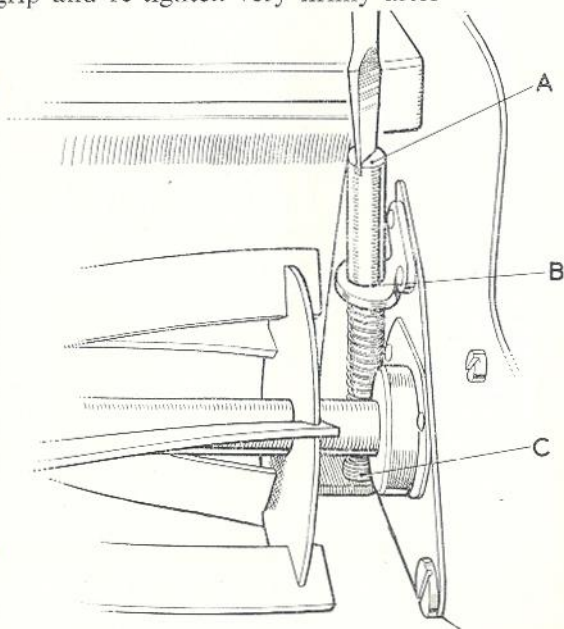

Fig. 12

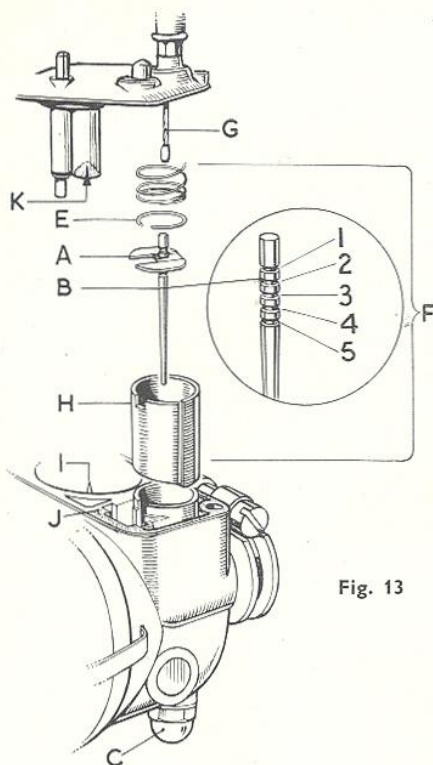

Fig. 13

can be achieved by turning the groove plate, which is dished, upside down before refitting. With the raised portion of the groove plate uppermost the mixture is enriched and vice versa. The preceding remarks relate to conditions in Great Britain. In overseas territories considerably more adjustment may be necessary to ensure that the best performance is obtained, especially in very hot climates or for work at appreciable altitudes.

To remove taper

Needle (B, Fig. 13)

Undo two screws (C, Fig. 14) holding carburettor body cover in position and remove body cover, taking care not to damage the gasket (J, Fig. 13). The throttle slide assembly (F, Fig. 13) will come away with the cover. Now close throttle lever, and by pressing throttle inner cable (G, Fig. 13) into the throttle slide (H, Fig. 13), the cable anchorage at the bottom of the throttle slide is moved clear of its seating and can be pushed across into the release channel. The cable and coil spring can now be withdrawn. Now place the palm of the hand over the opening in the throttle slide and carefully push the taper needle through until the groove plate retaining spring ring (E, Fig. 13) has been removed safely into the palm of the hand. NOTE. Before removing taper needle

completely, check the position of groove plate (A, Fig. 13) in the needle, i.e., the notch in which it is located and also the way the groove plate has been fitted. (One side is dished). Reverse the above procedure to re-assemble the throttle slide assembly to the cover. To refit this assembly into the carburettor body ensure that the gasket is not damaged and is seated on the face of the cover. Then enter the throttle slide into its chamber making sure that the taper needle first engages the needle jet and also that the keyway in the slide engages the key in the chamber. Care should now be taken to ensure that the fuel needle (I, Fig. 13) in the float chamber locates in the tapered hole of the cover (K, Fig. 13) before tightening down the screws which secure the cover to the body. Failure to do so will bend the needle and flooding of the carburettor will result.

To locate fuel gauze filter (E, Fig. 15)

Undo the banjo union bolt (H, Fig. 15) located under the carburettor and remove fibre washer (G, Fig. 15) banjo union (F, Fig. 15), and fuel gauze filter (E, Fig. 15).

The main jet

This can be detached for cleaning after removing the the domed nut (C, Fig. 13). Cleaning should be done by compressed air *and not by the use of wire* as this is likely to alter the size of hole and cause trouble with carburation.

MAGNETO

The magneto is correctly adjusted when leaving the works, and will subsequently be cleaned, tested and re-adjusted during complete overhauls. In the unlikely event

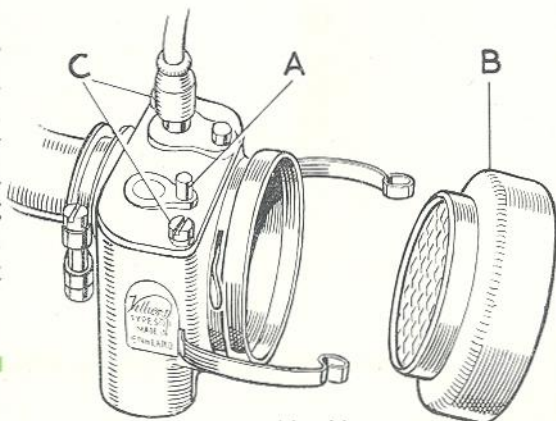

Fig. 14

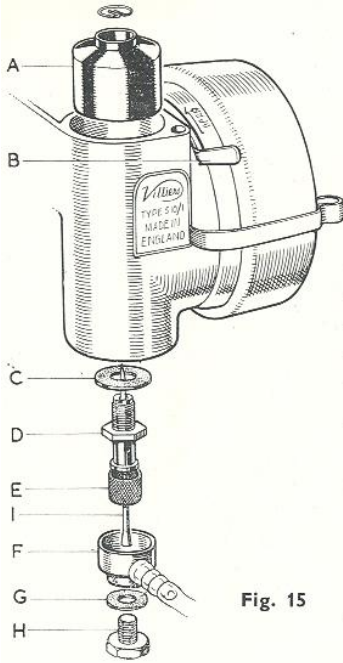

Fig. 15

of magneto failure occurring between servicing periods, it is recommended that it receives the attention of an expert from the local Atco branch.

The magneto timing is correct when the magneto points break $\frac{3}{32}$ in. before the piston is at the top of its stroke. The magneto points should open to the maximum extent of .015 in.

AIR FILTER

To avoid the ingress of abrasive dust and grit into the carburetter and engine, remove the air filter from the carburetter before starting engine and dip in *thin oil*. Allow surplus oil to drain away and then replace.

Thereafter the filter should be regularly removed, washed thoroughly in petrol, dipped in thin oil and replaced. In dry or dusty conditions this operation should be repeated more often.

T.V. Suppressor

A suppressor against T.V. interference is fitted in the high tension lead plug cap.

WINTER STORAGE

Before putting the machine away for storage during the winter months, it is very necessary to carry out the following procedure.

Remove sparking plug, squirt one teaspoonful of engine oil into the sparking plug hole. Turn engine over a few times in order to leave an oil film on the cylinder walls. Then replace plug.

Remove all dirt and dust. Lubricate all moving parts. Smear oil over cutting faces of knives and bottom blade. Ensure that the petrol tank and carburetter are empty. Swill out tank with a weak mixture of petrol and oil so that a protective film of oil is present inside.

NOTE. It is unwise to use "stale" petrol which has been in store in your shed through the winter months. The container may not have been airtight and the resultant steady evaporation of the volatile content of the petrol is a condition which is often a contributory factor in cases of bad starting at the beginning of a mowing season.

Wrap brown paper around engine. Cover machine up and store in a *dry* place.

IMPORTANT. *To the owner* — it should be particularly noted that items such as the cleaning of sparking plugs and jets, the adjustment of chains, cutters, etc., do not come under the Guarantee. While the services of our representatives are available for the carrying out of minor adjustments, a charge would be required to be made to defray time and journey expenses.

Full particulars of all such adjustments and the necessary information in regard to plug cleaning, etc., are clearly set out in this Instruction Book and are capable of being attended to, from the information given, without special mechanical knowledge.

The

ATCO

Service

Organisation



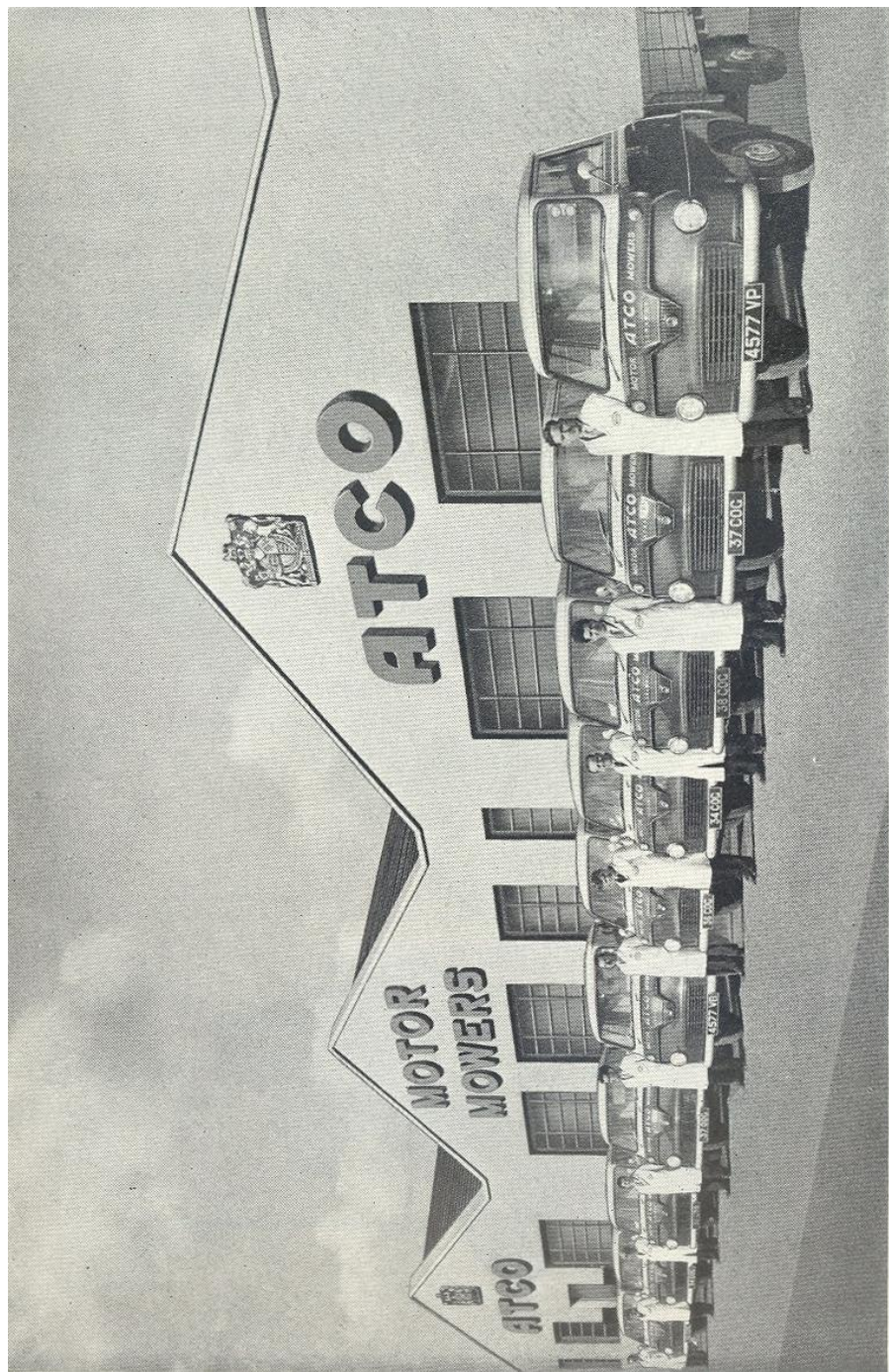

A typical Atco Branch. Standing in front of it is part of its modern fleet of Atco vehicles. Similar fleets are attached to each of Atco's ten Service Branches.

The Modern Motor Mower . . .

. . . is such a reliable, willing and commonplace piece of equipment that it is easy to overlook that all too often its working life is spent in conditions that, from a mechanical point of view, make very heavy demands upon it. These conditions can vary from rock-hard surfaces producing an all-enveloping dust cloud, to the mud and slime of the Spring and Autumn crop of worm casts. Add the hazards of the unsuspected stone or, from the cutting blades point of view, similar "hard objects" and the need for Service immediately becomes apparent.

Whether that need is brought about prematurely by misadventure or as a result of normal usage, it is prudent to get into touch with a prompt and reliable firm of specialists, whose undivided services are always available — and who more qualified than those intimately concerned with its design and production — the manufacturers themselves !

an assembly is a spec-
ature throughout the
) Organisation. These
sant working condit-
have promoted ext-
nt relations between
and management
have raised efficiency
high level.

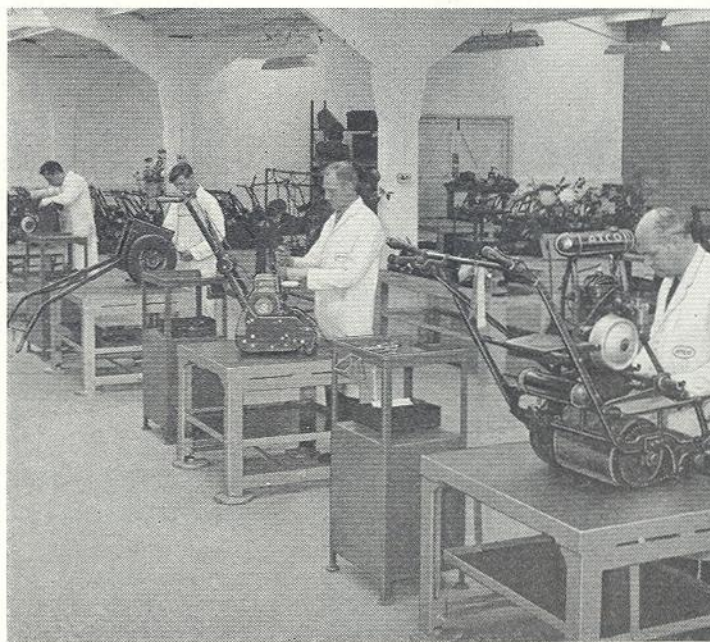



Similar Atco vehicles to this one are bringing in Service work daily to their respective Branches. The one illustrated is delivering a load of new machines to the trade.

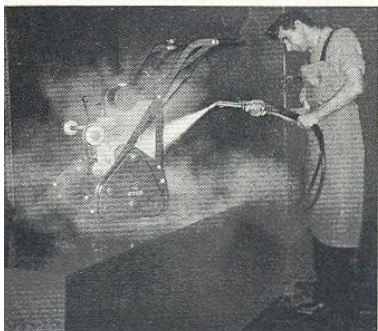

A high pressure paraffin jet cleans off all the caked oil, grease and dirt prior to the machine being dismantled for overhaul.

All the old painted parts are cleaned down to the bare metal in a chemical bath in preparation for repainting. Extractor fans are used to exhaust fumes out of the factory.

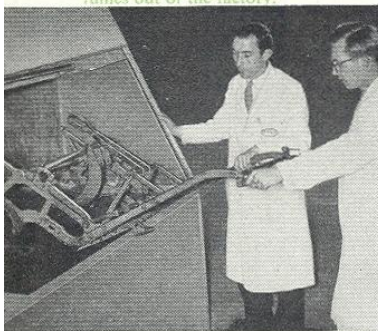

After cleaning and drying, the parts are restored to their former glory in the paint spray booth.

The Service Which Backs Your Purchase

We, at Atco, realised the need for such a Service Organisation as far back as 1921, when we launched our first Motor Mower, and in 1922, the first of our nation-wide network of Company - owned and fully maintained Sales/Service Branches came into being.

Our Service Organisation has no parallel in the entire industry. Each Branch is equipped with the most up-to-date machinery and is manned by highly skilled, Atco-trained personnel. The production methods and general layout conform to a standard pattern throughout the whole organisation, while workshop cleanliness is an "eye-opener" by any engineering standards.

Meanwhile, a careful examination to determine the replacement parts needed is carried out by the Shop Foreman.

No Matter Where You Live . . .

. . . Atco service is on your doorstep! Each Branch territory is subdivided into several small areas in which fully mobile Atco representatives are based. So wherever the User is, there is always an experienced Atco Service engineer near at hand to discuss his requirements and to take the appropriate action, whether it is for the quick emergency job on the user's own lawn, or for the part or full treatment at the Branch Workshop.

Each Branch also has a large fleet of expertly maintained, modern vehicles, many of which are in daily touch with every part of the territory, so not a single moment is wasted either for collection or redelivery of service undertakings.



Spares are the "life-blood" of the Atco Service Organisation and modern binning systems have been installed at each Branch.

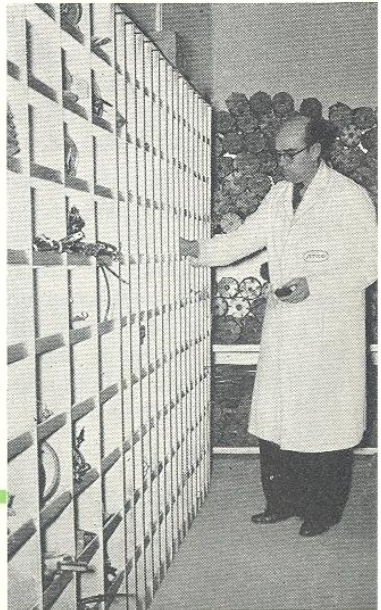

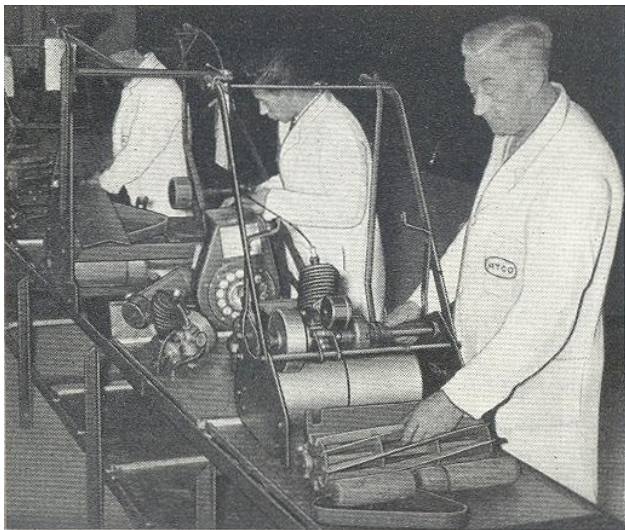

Each machine, with its works order label attached, is expertly rebuilt on the modern assembly lines by experienced Atco trained technicians.

Quick Summer Service

Ever conscious of the need for Branch expansion to keep ahead of a rapidly growing service demand as more and more Atcos are annually put into service, we are constantly reviewing the situation, and from time to time, existing buildings have been added to and in several cases entirely new Branch premises have been, and are still, being built.

No longer need there be any concern at releasing an Atco for Servicing during the Summer months, since by the introduction of modern methods and machinery in addition to substantial increases in Atco transport and personnel, a machine can be quickly and efficiently serviced and redelivered within a few days of collection. Furthermore, in a real emergency, a loan machine from the special "Loan Fleet" held at each Branch can usually be provided while the user's Atco is being serviced !

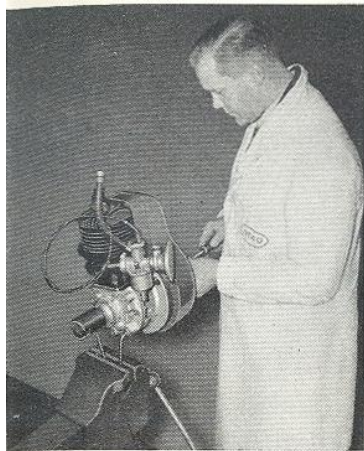

A specialist stripping down an engine — under the complete reconditioning scheme.

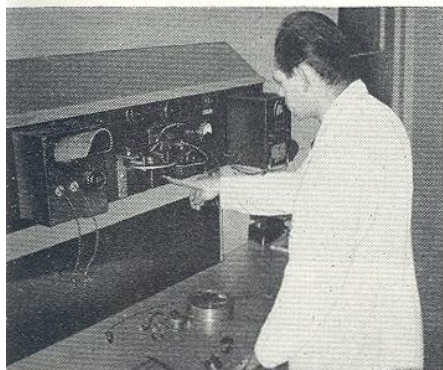

An expert checks the efficiency of a flywheel magneto on a special test rig.

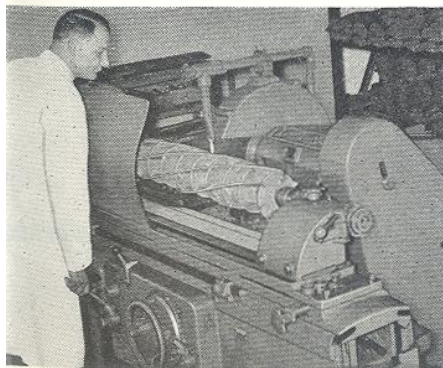

A Special Reconditioning Scheme

The photographs supporting this introduction to our Service Organisation tell their own story and illustrate important facets of the work that takes place at each and every one of our Branches.

One of the special features of the services we have to offer is our complete reconditioning scheme, the subject dealt with by many of the photographs. It consists of stripping the product down to its smallest components, all of which are expertly examined and replaced where necessary, while the painted parts are chemically treated to remove old paint and grease and resprayed to a high standard of finish. When the whole machine is rebuilt by experienced mechanics, it is in appearance and functionally, a showroom specimen and a credit to men who take a pride in their work !

A 34 in. cutting cylinder being trued up on a grinding machine, which is an essential part of the modern plant at each Atco Branch machine shop. Complete exchange regrind sets of cutting cylinders and bottom blade are a special feature of Atco Service.

The Important Thing To Remember . . .

. . . about us is that the manufacture and subsequent servicing of motor mowers are not just sidelines for us but a full time occupation. Our interest does not end with a sale ; we want to, and do ensure, wherever permitted, that every Atco not only gives a good account of itself, but that it continues to do so for many years. Many of our early models, we are proud to say, are still doing an active job today !

Furthermore, this close association with our products in the field provides us with a flow of information about design improvements which enables us to set a standard for the Motor Mower Industry.

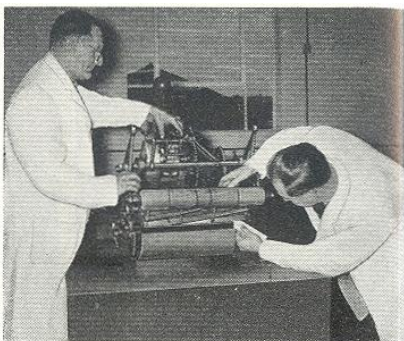

An early Atco model receiving the personal check of the Deputy Manager at the end of the Assembly line.



The final running tests are carried out in an air conditioned cubicle where an extractor fan carries the harmful exhaust fumes beyond the factory walls. From here the passed out machine is loaded on to Atco transport for redelivery to the User.



The spacious, modern general office at a typical Atco Branch; the nerve centre of its administration. Here also, are kept the history cards of many thousands of Atcos in the field, some dating back to the early 1920's.



SERVICE BRANCHES

DARLINGTON
(Co. Durham)
396 North Road.
Telephone : Darlington 2671
and 66939.

SCOTLAND
Industrial Estate,
Larkhall, Lanarkshire.
Telephone : Larkhall 370
and 371.

SHEFFIELD (Yorks.)
Rotherham Road,
Eckington.
Telephone : Eckington
2373-4

N. IRELAND
Stanley Harvey & Co. Ltd.
Clarence Street West,
Belfast.
Telephone : Belfast 31057
to 9 (3 lines)

PRESTON (Lancs.)
The Grove, School Lane,
Longton, Nr. Preston.
Telephone : Longton 2451-
2 and 3.

EIRE
Irish Atco Limited.
16/18 Orwell Road,
Rathgar, Dublin.
Telephone : Dublin 907122.

BIRMINGHAM (Warks.)
1210 Stratford Road,
Hall Green.
Telephone : Springfield 2132,
3923.

NEWMARKET (Suffolk).
176 Exning Road,
Telephone : Newmarket
2539, 2632.

CHEPSTOW (Mon.)
Castleford, Tutshill.
Telephone : Chepstow 2732,
2114.

READING (Berks.)
Boulton Road,
Telephone : Reading 84258
and 9.

EXETER (Devon)
Marsh Green Road,
Marsh Barton,
Telephone : Exeter 73882
and 54017.

LONDON
Progress Way, Purley Way,
Croydon, Surrey.
Telephone : Croydon 3471-
2-3-4.

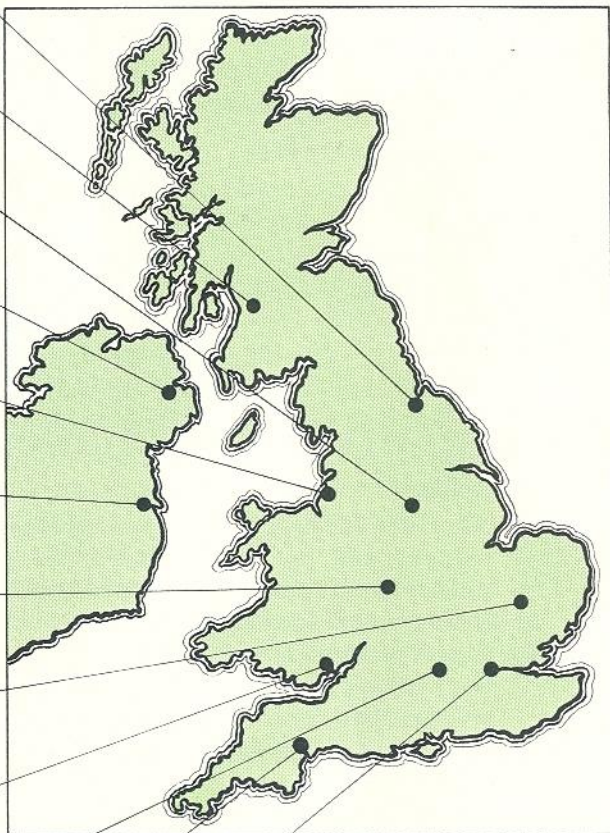

We would genuinely welcome a visit from our Users, or prospective Users, for the short time necessary to see the Atco Service organisation at work. This can be arranged at any time by our Head Office at Atco Works, Birmingham, or better still, direct with the Manager of the Service Branch with whom your Atco Motor Mower is registered, and whose address will be found in the list above.

continued from page 16

Turfing is a job for the late autumn or early winter months and it is worth trying to finish before Christmas.

In the following year further rolling will be required in the spring and also probably additional top dressing followed by normal maintenance.

9. **Grassing flower-beds**

Thorough preparation is required as above. When levelling, care should be taken to ensure not less than 4 in. top soil. When ready for seeding, the finished firm seed bed should be flush with the adjacent lawn or only very slightly proud. When preparing for turfing, allowance has to be made for the thickness of the turf which should itself finish flush with the adjacent lawn.

MAINTENANCE OF EXISTING LAWNS

1. **Rolling**

After the effects of winter some rolling in the spring is required and for most lawns a two cwt. roller should suffice, special care being taken at the turns. If the spring rolling is done in the right conditions it should be the only time it is necessary or justified in normal circumstances. Over-rolling results in a bad physical condition of the soil and leads to its over compaction. This in turn creates aeration difficulties and impedes the percolation of moisture.

The roller is often over used to flatten out surface irregularities. The operation may be fairly successful but is costly in terms of turf quality, vigour, etc. It is better to use repeated top dressings to fill up depressions.

2. **Mowing**

Frequency and height of cut influence greatly the characteristics of turf. Vigour, composition and quality

of a sward are governed to a large extent by the mower and how it is used.

Irregular and over close cutting removes more leafage and impairs the rooting system. This leads to the development of weak areas which tend to fill up with the shallow rooted annual meadow-grass, weeds or moss.

Sound maintenance should consist of regular mowing (once or twice per week) at a height of cut most appropriate for the grass which forms the turf and which is suitable for the state of growth and season of the year. Whilst lawns composed of the finer grasses can be maintained satisfactorily for ornamental purposes at a height of approximately $\frac{1}{4}$ in. during the growing season, many of the coarser species would be better maintained at a $\frac{1}{2}$ in. or $\frac{3}{4}$ in. Discretion must, therefore, be used bearing in mind the composition of the sward. In periods of drought and early and late in the season it is, of course, desirable to allow a little extra grass cover. It is beneficial to change the direction of mowing regularly.

In the autumn and winter period, cutting should not be neglected and if growth has taken place the lawn should be topped at something like twice the height of cut employed in the growing season.

If the sward is clean the occasional return of cuttings can be helpful in periods of drought when they act as surface mulch. Generally, however, the cuttings are best removed for their constant return will provide ideal conditions for earthworm activity, tend to increase annual meadow-grass and produce a soft spongy surface condition which makes the turf more susceptible to disease.

3. Fertilizer Treatment (Feeding)

Discretion is needed here since a lawn can be spoiled

either by starvation or by over-feeding, especially if the wrong kind of fertilizer is used.

A good lawn may need a complete fertilizer in the spring. A reliable proprietary mixture may be used or a mixture made to a formula such as:

2 lbs. sulphate of ammonia	} per 100 square yards
1 lb. dried blood	
4 lbs. superphosphate	
1 lb. fine bone meal	
1 lb. sulphate of potash	
1 lb. calcined sulphate of iron	

A mixture such as this should be well mixed with about 28 lbs. of screened sandy soil or compost per 100 square yards to facilitate uniform distribution and minimise scorch risk. Showery weather in the spring should be chosen.

If further fertilizer is required then it should be mainly nitrogenous, e.g.

2 lbs. sulphate of ammonia	} per 100 square yards
1 lb. dried blood, with	
28 lbs. screened sandy soil	

If dry weather follows fertilizer application it is wise to water in carefully before two or three days have elapsed. Usually no fertilizer is desirable between the end of August and the following spring.

4. Watering

The effects of watering are not all good but in dry weather it may well be necessary to water to keep the lawn alive, especially if it is of high quality. The rules are simple — water early (before the lawn has started to suffer), water adequately and water often (whilst the dry weather lasts).

5. Scarification

Scarification in spring and on occasions throughout the season is an important factor in keeping the sward healthy. This operation is best carried out when growing conditions are good. A wire rake is a suitable implement. Its object is to remove the accumulation of dead grass leaves and superfluous fibrous matter and to reduce the “nap” caused by creeping types of grasses. It also assists the entrance of air and moisture and produces a quicker reaction from feeding.

6. Aeration

Air is required for the grass roots to function properly and to aid the chemical and biological processes in the soil. Some form of spiking is, therefore, often useful to let air into the soil, to let moisture through the surface and also to relieve soil compaction created by mowing implements, treading and the (usually unnecessary) use of the garden roller.

Thorough aeration is best carried out in the autumn when conditions are most suitable for obtaining maximum penetration. The job can be done by means of a special fork or a machine. Whichever implement is used solid tines are usually most appropriate but on heavy soils, or where the sward is excessively matted, hollow tines can be used to advantage at this time. Deep forking is not necessarily an annual job — every two or three years is probably adequate.

Comparatively shallow spiking (as with a spiked roller) throughout the growing season will assist the penetration of moisture (natural or artificial) and produce better results from fertilizer application.

7. Top Dressing

This is an essential operation for the maintenance and improvement of existing surfaces and also for improving the physical condition of the surface soil.

The best top dressing material is derived from a compost heap produced by rotted organic material and top soil, made friable by the addition of sharp lime-free sand and suitably screened before application. It is not always possible to produce a natural compost like this but a substitute mixture can be made from, for example, soil, sand and peat mixed together in proportions which are suitable for local requirements and conditions, e.g.

10 parts screened top soil
10 parts sharp sand
1 part granulated peat

Top dressing material can be spread by hand or shovel. It should be applied to a dry surface fairly evenly and then smoothed out with the best means available. A proper drag mat or drag brush is best but quite good results can be obtained with the back of a wooden rake or even a door mat. The idea is to smooth out the loose material we have just applied so that more is left in the hollows than on the bumps, care being taken to avoid smothering of the grass nevertheless.

Heavy applications for surface improvements (from 1 - 7 lbs. per square yard) are best made in the autumn or early spring. Avoid applying more material in any one dressing than can be comfortably worked through the sward as smothering of the sward will weaken the grass and may lead to an outbreak of disease.

Light top dressings during the growing season are also beneficial particularly in periods of drought when they act as a useful surface mulch. Top dressing is without doubt

the most effective way of building up a true surface which is necessary for uniform mowing and a really good looking lawn.

8. Weeds

Most lawn weeds can be effectively controlled by selective weed-killers purchased in proprietary form if these are used efficiently. They should be applied during a spell of fine weather but when there is sufficient moisture in the soil to ensure good growing conditions. Selective weed-killers are bought in liquid form usually and applied by means of a watering can or fine spray. Flowers and shrubs are very susceptible to these chemicals so great care is necessary. With a sprayer there may be risk of drift on to the flower beds and so it is usually wise, except on very large lawns, to apply the weed-killer with a watering can which must be thoroughly rinsed out after use.

9. Moss

Usually the presence of moss is an indication that there is some restriction on the growth of grass. Removing the restriction is then the best way of curing moss. Moss may be caused by bad drainage, shading by trees, over acidity, shortage of plant foods or other factors and attention to such of these points as apply is most important if the moss is to be eliminated.

Moss is resistant to selective weed-killers but can be tackled by means of a "lawn sand" mixture such as:

3 lbs. sulphate of ammonia	} per 100
1 lb. calcined sulphate of iron, with	
28 lbs. screened sandy soil	

This mixture also should be applied during the growing season but it is meant to scorch so a few days sunny

weather help it to work. Watering should, however, follow before too long.

10. **Earthworms**

Earthworms lead to a bumpy surface and encourage weeds and weed grasses. Avoid treatments which encourage earthworms, e.g., unnecessary liming and excess of organic fertilizers. Earthworm control can be effected by using one of a number of materials available for the purpose, e.g., a Derris Dust or best of all, where it is considered safe to use, lead arsenate powder at $1\frac{1}{2}$ - 2 ozs. per square yard. Whatever material is used to control the earthworms it is usually best to carry out the operation in warm damp weather when the worms are working near the surface, usually in autumn or possibly spring.

11. **Disease**

There are quite a few turf diseases but the most common one found on lawns is Fusarium Patch disease which thrives particularly in mild periods in autumn and spring but is also found after snow has laid on the ground for some time. The first symptoms are small brown or yellow patches which may increase in size and if unchecked coalesce and continue to increase in size, the grass dying off. Disease prevention involves avoiding excessive fertilizer treatment, particularly over late applications of nitrogenous fertilizer; keeping the sward clean and never smothering with top dressing, etc.

For control of Fusarium Patch disease, there are a number of reliable proprietary fungicides and usually it is worthwhile treating the whole lawn once the trouble starts.

For further information on Lawn Culture, etc., a new Penguin Book by R. B. Dawson entitled "Lawns for Garden and Playing Fields" is obtainable — price 6s.